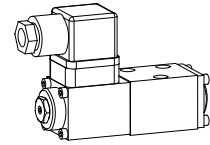

Solenoid operated spool valve

- 4/2-way impulse valve
- 4/3-way with spring centred mid position
- 4/2-way with spring reset
- $Q_{max} = 15 \text{ l/min}$, $p_{max} = 350 \text{ bar}$

NG3-Mini®

DESCRIPTION

Direct operated solenoid valve with 4 ports in 5 chamber design. Spool detented or with spring reset. Precise spool fit, low leakage, long life time. Threaded ports through additional base plate. Spool made from hardened steel, body from high quality cast steel. Wide range of standard and special voltages. The body made of high grade hydraulic casting for long service life is painted. The solenoid and the cover are zinc coated. The socket head screws are zinc coated.

FUNCTION

- 4/2-way detented spool valve: 2 solenoids and 2 detented positions. With the solenoids deenergised the spool remains in the last switched position.
- 4/2-way spool valve: 1 solenoid and 2 spool positions, spring off-set. With the solenoid deenergised the spool returns to the offset position.
- 4/3-way spool valve: 2 solenoids and 3 spool positions, spring centered. With the solenoids deenergised the spool returns to the center position.

APPLICATION

Spool valves are mainly used for controlling direction of movement and stopping of hydraulic cylinders and motors. Direction of movement depends on the position of spool and its flow symbol. Please pay attention to the performance limits and leakage of the valves. Solenoid operated spool valves are suitable for machine tools and handling systems. Miniature vales are used where both, reduced dimensions and weight are important.

TYPE CODE

Interface acc. to Wandfluh standard	B	M	4		-		#	
Medium-solenoid								
Number of control ports								
Description of symbols acc. to table								
Nominal voltage U_N	12 VDC	G12						
	24 VDC	G24						
	110 VAC	R110						
	115 VAC	R115						
	230 VAC	R230						
Design-Index (Subject to change)								

GENERAL SPECIFICATIONS

Description	4/2-, 4/3-spool valve
Nominal size	NG3-Mini to Wandfluh standard
Construction	Direct operated spool valve
Operation	Solenoid
Mounting	Flange
	3 fixing holes for socket head screws M4x30
Connections	Threaded connection plates
	Multi-flange subplates
	Longitudinal stacking system
Ambient temperature	-20...+50°C
Mounting position	any, preferably horizontal
Fastening torque	$M_D = 2,8 \text{ Nm}$ (screw quality 8.8)
Weight: 4/2-way impulse	$m = 0,65 \text{ kg}$
4/3-way	$m = 0,65 \text{ kg}$
4/2-way (1 solenoid)	$m = 0,50 \text{ kg}$

HYDRAULIC SPECIFICATIONS

Fluid	Mineral oil, other fluid on request
Contamination efficiency	ISO 4406:1999, classe 20/18/14 (Required filtration grade $\beta_{10...16} \geq 75$) refer to data sheet 1.0-50/2
Viscosity range	12 mm ² /s...320 mm ² /s
Fluid temperature	-20...+70°C
Working pressure in port P, A, B	$p_{max} = 350 \text{ bar}$ ($p_T < 20 \text{ bar}$) $p_{max} = 315 \text{ bar}$ ($p_T > 20 \text{ bar}$)
Tank pressure in port T	$p_{Tmax} = 100 \text{ bar}$
Max. volume flow	$Q_{max} = 15 \text{ l/min}$, see characteristics
Leakage volume flow	see characteristics

ELECTRICAL CONTROL

Construction	Solenoid, wet pin push type, pressure tight	Voltage tolerance	±10% of nominal voltage
Standard-nominal voltage	$U_N = 12$ VDC $U_N = 24$ VDC $U_N = 110$ VAC* $U_N = 115$ VAC* $U_N = 230$ VAC* AC = 50 bis 60 Hz	Protection class	IP 65 to EN 60529
		Relative duty factor	100% DF (see data sheet 1.1-430)
		Switching cycles	15'000/h
		Operating life	10^7 (number of switching cycles, theoretically)
	* Rectifier integrated in the plug, other nominal voltages and nominal performances on request	Connection/Power supply	Over device plug connection to EN175301-803 (DIN 43650) ISO4400, form A, (2P+E), other connections on request.
		Solenoid connection:	SIN29V (data sheet 1.1-80)

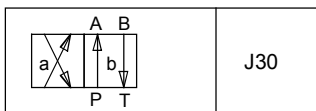
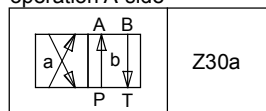
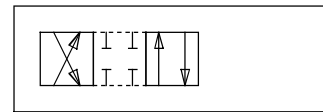
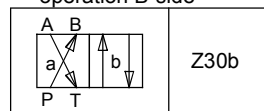
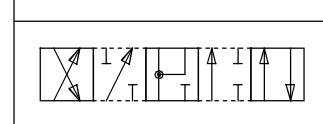
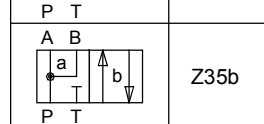
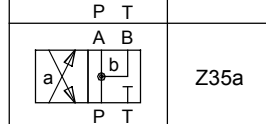
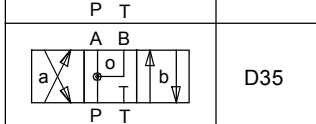
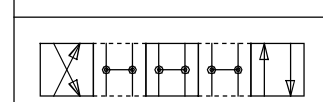
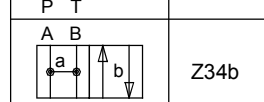
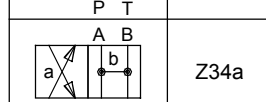
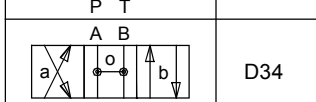
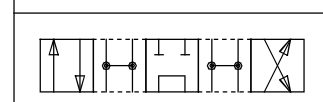
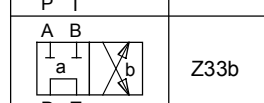
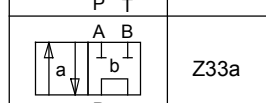
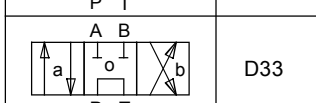
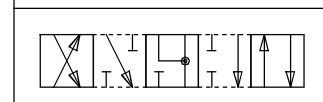
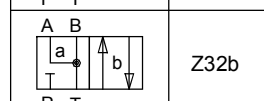
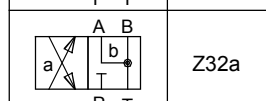
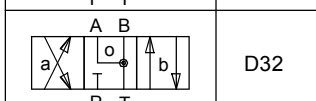
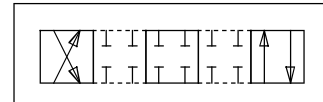
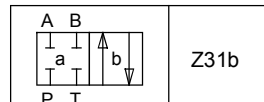
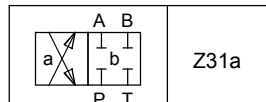
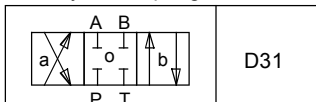
TYPE LIST / DESIGNATION OF SYMBOLS
4/2-way valve impulse

4/2-way valve with spring reset operation A-side

Transitional functions operation B-side

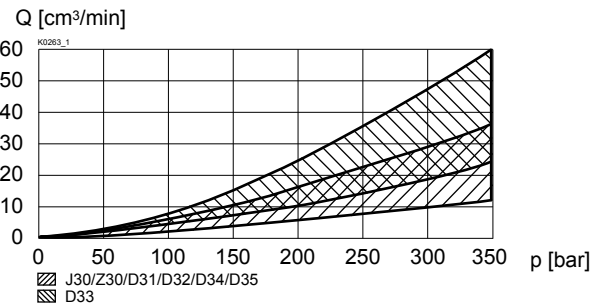
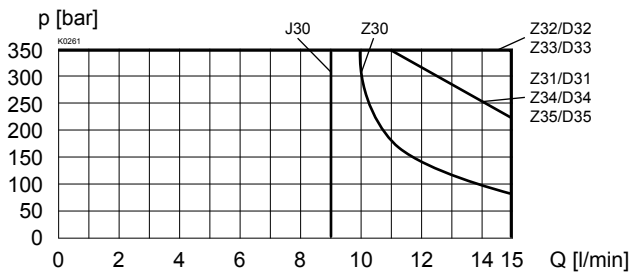
4/3-way valve spring centered

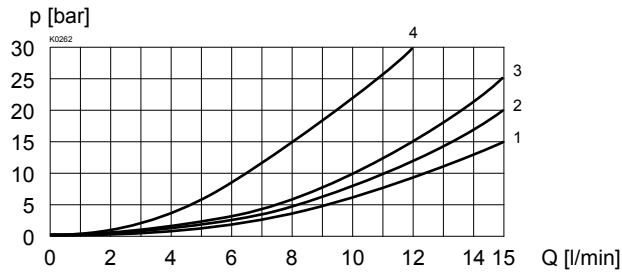
CHARACTERISTICS Oilviscosity $\nu = 30$ mm²/s

$p = f(Q)$ Performance limits with standard voltage -10%

$Q_L = f(p)$ Leakage volume flow characteristics per control edge



$\Delta p = f(Q)$ Pressure drop volume flow characteristics

Pressure drop Curve no. Symbol	Volume flow direction				
	P - A	P - B	P - T	A - T	B - T
Z30/J30	3	3	-	2	2
D31/Z31	3	3	-	2	2
D32/Z32	3	3	-	1	1
D33/Z33	4	4	3	4	4
D34/Z34	4	4	3	1	1
D35/Z35	2	2	-	2	2

DIMENSIONS

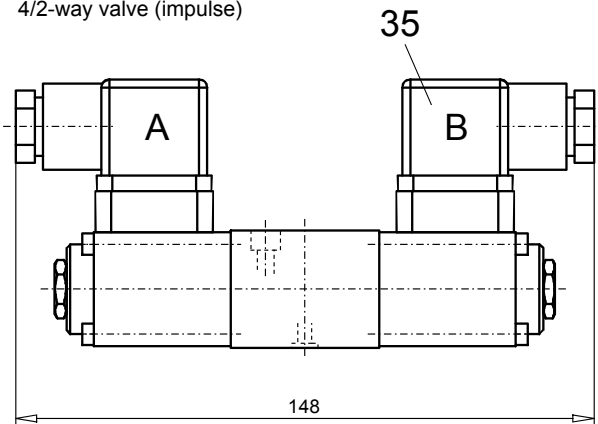
 4/3-way valve (spring centred)
 4/2-way valve (impulse)

4/2-way valve (spring reset)

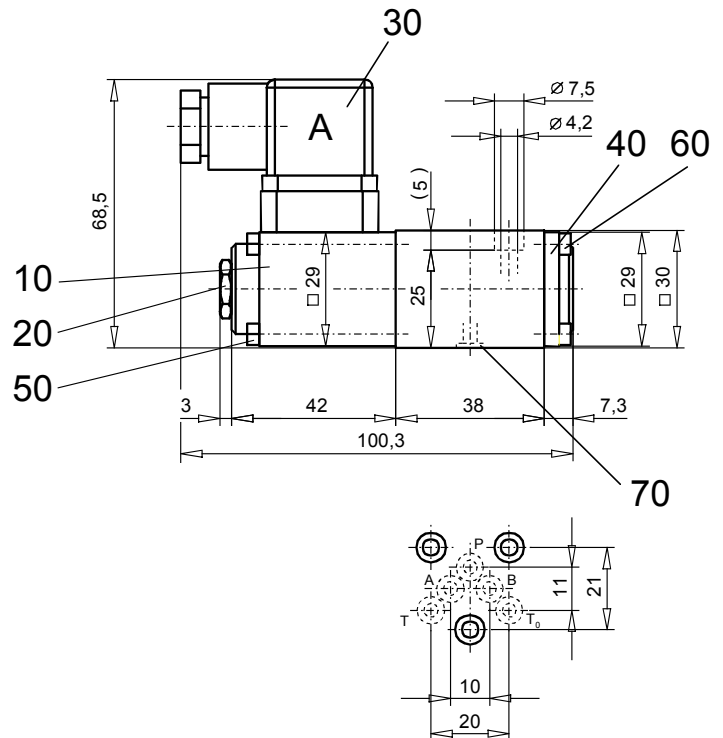
PARTS LIST

Position	Article	Description
10	260.2 ...	Solenoid SIN29V
20	253.8000	Plug with integr. manual override HB4,5
30	219.2001	Electric plug A (grey)
35	219.2002	Electric plug B (black)
40	56.4200	Cover
50	246.0141	Socket head screw M3x40 DIN 912
60	246.0109	Socket head screw M3x8 DIN 912
70	160.2045	O-ring ID 4,50x1,50

ACCESSORIES

 Threaded connecting plates, Multi-flange subplates and
 Longitudinal stacking system see Reg. 2.9

Technical explanation see data sheet 1.0-100